



Heating you can rely on
even in the coldest of winters



Daikin Optimised Heating 4. Engineered to beat the winter cold.

Why choose Daikin?





When the temperature drops below freezing, it's important you have the right system to maintain an ideal indoor climate. But your system should do more than just maintain temperature consistency, it should also be reliable, energy efficient and easily controlled.

With **more than 90 years of experience in climate control technologies**, we understand what it takes to create a comfortable environment for your home, business or office. That's why we are proud to introduce the latest edition of our Optimised Heating 4 range.

Backed by research from our European Development Centre, Optimised Heating 4 is a heating solution built in Europe, for North-European climates. Equipped with R-32 refrigerant and enhanced features, Optimised Heating 4 uses the latest technologies to achieve more energy efficiency and perfect comfort.

Discover how **Optimised Heating 4** can help you achieve **your perfect climate.**



Why choose Daikin's Optimised Heating 4

General features

Daikin Optimised Heating 4 was specifically engineered to perform at extreme outdoor conditions and temperatures as low as -25°C , making it the perfect fit for Scandinavian environments.

The system uses some of the industry's most cutting-edge technologies to achieve energy efficiency ratings of up to A+++ in heating. Moreover, intelligent features such as the heat boost and fireplace logic offer exceptional heating comfort – for high-quality, reliable and sustainable heating, even in the coldest of winters.

NEW

Optimised Heating 4 is now extended, offering **Stylish, Perfera and Comfora indoor unit ranges**, allowing you to choose from a variety of award-winning designs and high-tech features that suit your home perfectly.

Reliability

To guarantee the seamless operation of your heating system, even in temperatures as low as -25°C, the Optimised Heating 4 range offers enhanced features:

- › A large size compressor for **comfortable heating and capacity** whenever needed
- › Upgrades for **fewer defrost cycles**
- › Extended pipe and drain connections for **easier installation**
- › **Free hanging coil**: no need for a heater cable. This saves money and eliminates trouble when the heater cable breaks down.

The Optimised Heating 4 range also includes additional improvements to **reduce ice buildup**, such as:

- › An enhanced bottom plate to improve water drainage

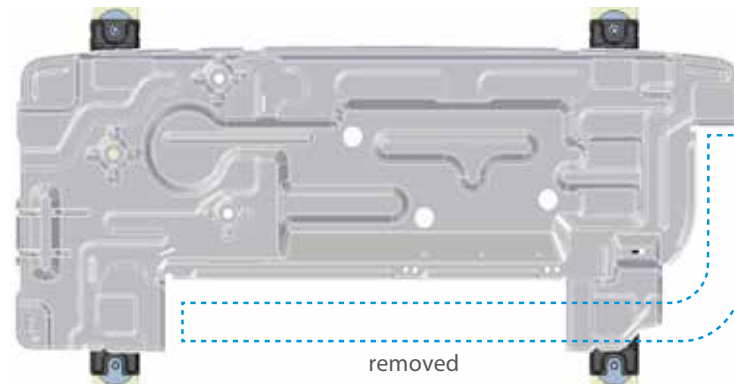

The bottom frame discharges water directly to the ground.



Additional benefits:

- › Releases melted ice around the heat exchanger
- › Prevents ice buildup between legs and brackets
- › Uses a vibration absorber to muffle vibrations

Easy installation

The Daikin Optimised 4 range also offers a quick and easy installation process, which includes:

Extended piping

This longer piping is specifically adapted to accommodate the thicker walls of Scandinavian buildings, and help contractors cut down on installation time.

Auxiliary piping is expanded to 50 cm to meet market demand and decrease installation time. It's also adapted to fit the wall thickness of Scandinavian houses.

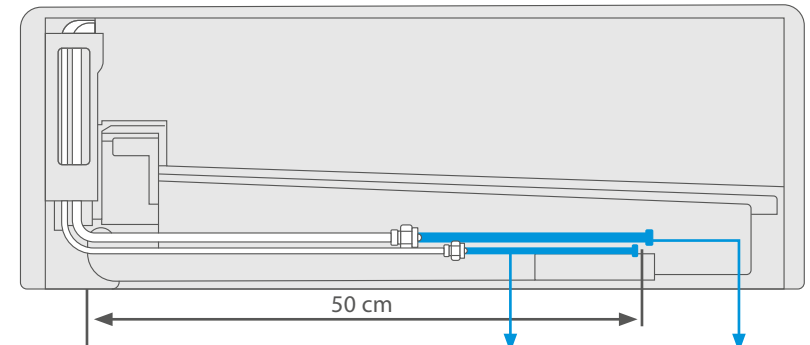

Stylish FTXTA30	+180mm	Extended drain hose	Extended auxiliary piping
Perfera FTXTM30	+180mm		
Perfera FTXTM40	+160mm		
Comfora FTXTP25-35	+180mm		

NEW Improved coil spring

With this improvement the pipes can be bent easier without deforming. For example in sharp angles the spring can be useful to avoid deformation of the pipe. Available on the full range.

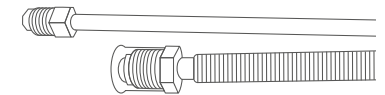

Improved lift handle

The newly designed handle helps installers easily carry an outdoor unit while wearing thick gloves.

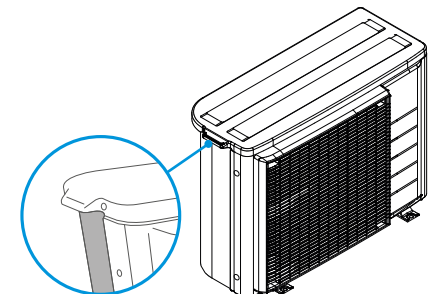



Efficiency **A+++** in heating

Designed for colder climates, Optimised Heating 4 creates a comfortable interior environment while maintaining excellent energy efficiency ratings.

Built to attain high energy efficiency at low ambient temperatures, Optimised Heating 4 achieves up to A+++ in heating with:

- › **R-32 refrigerant**
- › **Swing compressor:** enhanced compressor uses inverter technology and small capacity steps to adjust a unit's power and meet energy demands. In comparison to a rotary compressor, the swing compressor provides more energy savings, a lower risk for unit breakdown and quieter and vibration-free operation.

Silent operation

Daikin uses a **specially designed fan** that optimises airflow and creates high energy efficiency at low sound levels. Whisper quiet in operation: the operating of the unit can be hardly heard. The sound pressure level goes down to 19 dBA.

Together, the fan and heat exchanger produce top energy performance, yet operate at a sound level that is practically inaudible. Shhh!

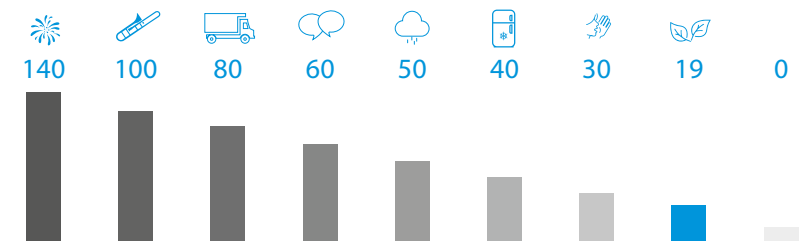

Air quality



Flash streamer (available on Stylish & Perfera)

Creating a healthy indoor environment is essential for regions with colder climates. Using electrons to trigger chemical reactions with airborne particles, the Flash Streamer removes allergens such as pollen and fungal allergens, eliminating unpleasant odours and providing better, cleaner air.

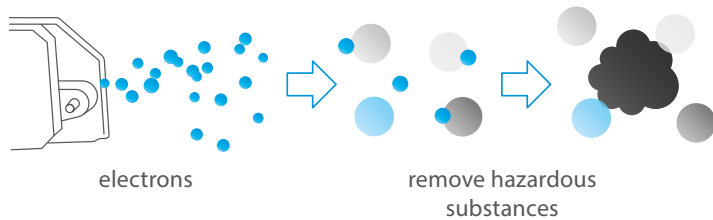

Titanium apatite deodorising filter (available on Stylish & Perfera)

The titanium apatite deodorising filter works hard to combat smells such as tobacco smoke and pets.

TITANIUM APATITE DEODORISING FILTER

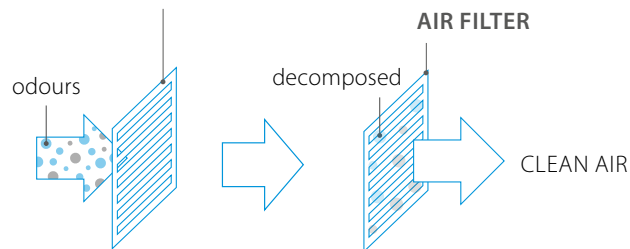

Silver allergen removal filter

The Silver allergen removal and air purifying filter is your solution, because it captures allergens such as pollen to ensure a steady supply of clean air.

Comfort



Heat boost

Heat boost quickly heats up your home when starting up your air conditioner. Set temperature is reached 14% faster* than a regular air conditioner (pair only).

*Heat boost test condition: 50 class, outdoor temperature 2°C - Indoor temperature 10°C, R/C setting: 23°C



The fireplace logic (available on Stylish & Perfera wall unit)

Daikin systems are flexible and easy to adapt for any room, including spaces that contain additional heat sources, such as a fireplace.

- › Rooms that contain a fireplace tend to be warmer and have a temperature that is higher than the original setting.
- › If the set temperature is reached in heating mode, the operation **Fireplace logic** will start automatically.
 - › During Fireplace logic operation, the indoor unit fan distributes the hot air across the room.
 - › The airflow rate depends on difference between set temperature and temperature in the room (higher temperature difference = higher airflow rate).
- › The air flow decreases, the more the room temperature gets to its original setting.

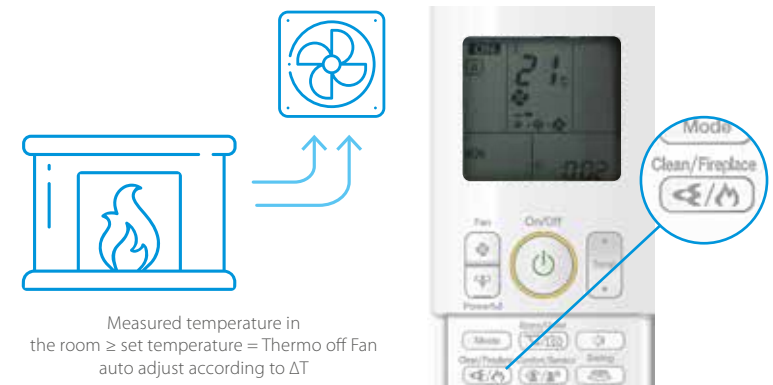

Fireplace activation button on remote control



Daikin Residential Controller app

Control your climate from any place, at any time.

NEW Voice control

The Daikin Residential Controller App is for those who live their life on the go and who want to manage their heating system from their smartphone. To provide users with even more comfort and ease, it now offers voice control. This hands-free feature cuts down on clicks to manage units faster than ever before.

Cross-functional and multilingual, voice control pairs well with any smart device, including Google Assistant and Amazon Alexa.

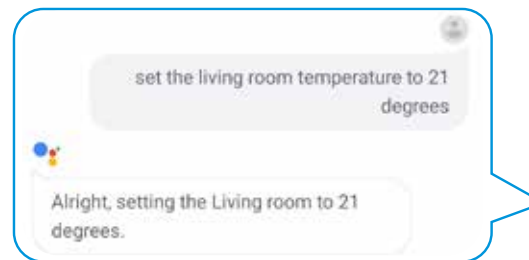

amazon alexa



works with the
Google Assistant

Your benefits

- › Access to various features for controlling your internal climate
- › Manage the temperature, operating mode, air purification and fans with the interactive thermostat
- › Create different operating schedules and modes
- › Monitor energy consumption

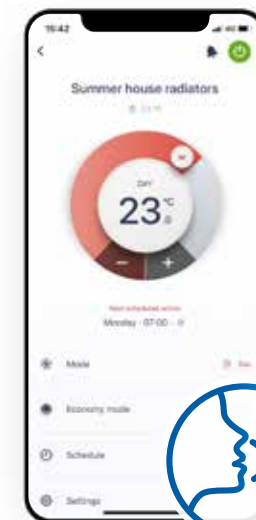

BLUEVOLUTION

The Daikin Residential Controller application can control and monitor up to 50 split air conditioning units. All Bluevolution units are connectable with the Daikin Residential Controller.



Control

Control operation mode, temperature, air purification, fan speed & direction

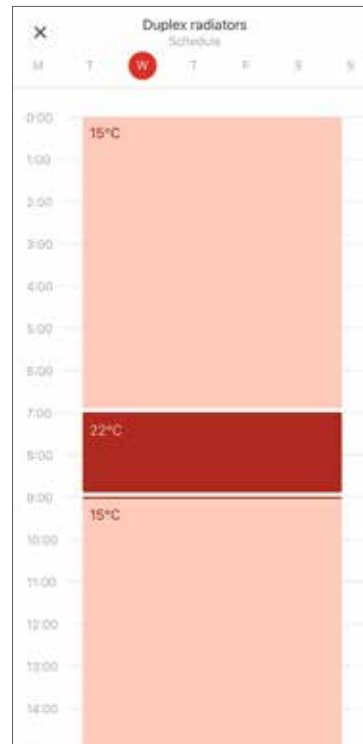

Schedule

Schedule the set temperature, operation mode and fan speed



Monitor

Monitor your energy consumption, set holiday schedule

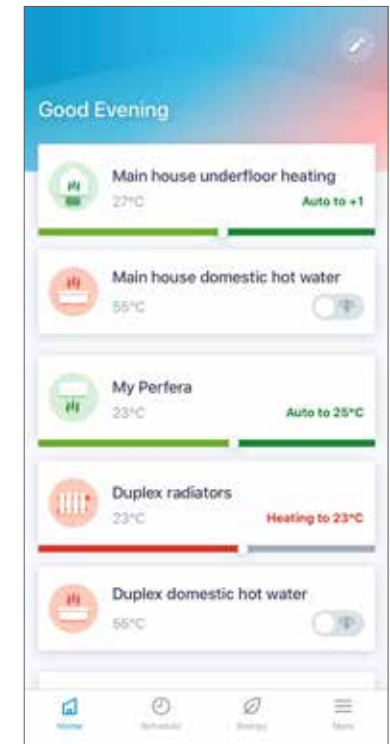

Identify

Identify the rooms of your house

stylish

Where innovation meets creativity



Why choose Stylish?

Stylish brings together excellent design and technology to deliver a total climate solution for any interior. Measuring only 189 mm, Stylish is the thinnest unit on the market in the design segment for wall mounted units and uses innovative features to achieve the best in comfort, energy efficiency, reliability and control.

Award-winning design

Inspired by its predecessors, Daikin Emura and Ururu Sarara, Stylish earned the Good Design Award for its innovative look and functional capabilities. This award also recognises Stylish for its ability to achieve new standards of comfort and energy efficiency in the HVAC-R industry.



red dot award 2018
winner



GOOD DESIGN
AWARD 2017

The Coanda effect

The **Coanda effect** optimises the airflow for a comfortable climate. By using specially designed flaps, a more focused airflow allows a better temperature distribution throughout the whole room.

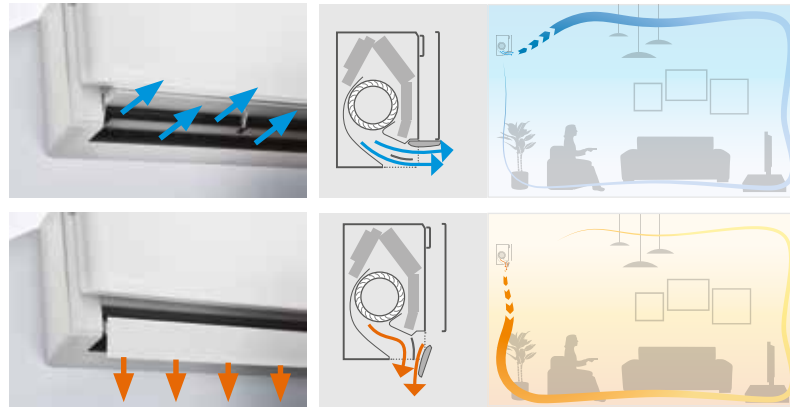

The Coanda effect creates two different airflow patterns depending on whether Stylish is in cooling or heating mode. On the top is the Coanda effect in cooling mode (ceiling airflow), while the bottom images demonstrate the Coanda effect in heating mode (vertical airflow).

Stable room temperatures

Stylish uses an **intelligent thermal sensor** to detect the surface temperature of a room to create a more comfortable climate.

After determining the current room temperature, the intelligent thermal sensor distributes air evenly throughout the room before switching to an airflow pattern that directs warm or cool air to areas that need it.

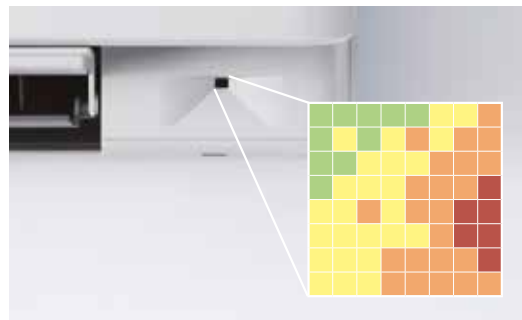

The intelligent thermal sensor measures the surface temperature of a room by dividing it into a grid with 64 different squares.

Quiet operation

Stylish uses a **newly designed fan** to optimise airflow for higher energy efficiency at low sound levels.

To achieve higher energy efficiency, Daikin designed a new fan that runs efficiently within Stylish's compact dimensions. Together, the fan and heat exchanger attain top energy performance but operate at a sound level that is practically inaudible to occupants.

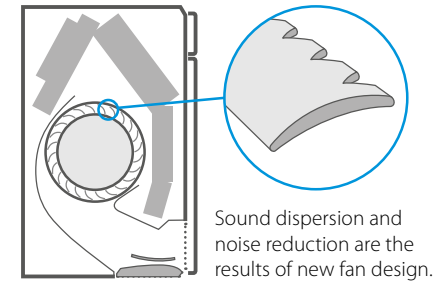

Flash streamer

Using electrons to trigger chemical reactions with airborne particles, the Flash Streamer removes allergens such as pollen and fungal allergens, eliminating unpleasant odours and providing better, cleaner air.

Fireplace logic

When installed close to a heating device (e.g. fireplace or oven) and the set temperature is reached, the fan keeps on running to have an even temperature throughout the whole house.

Energy efficiency

Stylish achieves higher energy efficiency and lower environmental impact with refrigerant R-32.

up to
A⁺⁺
in cooling

up to
A⁺⁺⁺
in heating

Available in
2 colours:

White FTXTA-BW



Black FTXTA-BB



perfera

wall mounted unit

makes warm living and working a breeze



Why choose Perfera?

Whatever the weather's doing outside, inside you want optimum comfort throughout the day. Perfera instinctively knows how to keep the room temperature in your living or working space at the ideal level, so that you and those around you can get on with relaxing, enjoying yourselves – and being productive. The eye-catching designed front panel, whisper-quiet operation and the perfect circulation of heated or cooled air help make each room the place you – and everyone – always want to be.

Technology meets design for the ideal climate solution

While the outside of the new Perfera is all about eye-catching design and style, it's the inside that creates the perfect indoor climate.

3-D 3-D Air flow

By pressing the buttons on the remote control, this function combines vertical and horizontal auto-swing to circulate a stream of cool/warm air right to the corners of even large spaces.

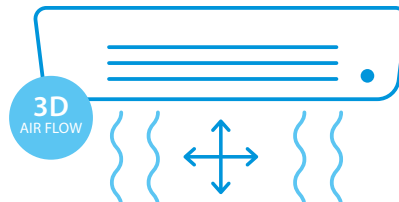

The side of the panel emphasises the strong airflow of the unit



2 area motion detection sensor

Air flow is sent to a zone other than where the person is located at that moment. Detection is done in 2 directions: left and right. If no people are detected, the unit will automatically switch over to the energy-efficient setting.

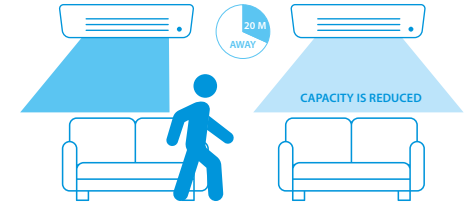

Flash streamer

Using electrons to trigger chemical reactions with airborne particles, the Flash Streamer removes allergens such as pollen and fungal allergens, eliminating unpleasant odours and providing better, cleaner air.



Fireplace logic

When installed close to a heating device (e.g. fireplace or oven) and the set temperature is reached, the fan keeps on running to have an even temperature throughout the whole house.

Energy efficiency

The enhanced design of the Perfera boosts energy efficiency even further compared with previous models. It boasts a seasonal energy efficiency ratio (SEER) of up to 7.60 and a seasonal coefficient of performance (SCOP) of up to 5.12. This gives the Perfera **best-in-class performance**, with seasonal efficiency values up to A+++ in heating and cooling resulting in low running costs. The Perfera is an energy-saving winner from every angle.

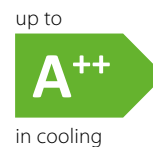



perfera

floor standing unit

designed for heating,
makes your world comfortable



Why choose Perfera?

Whatever you're planning to do with your day, you want to be comfortable while you're doing it. Whether it's the coolness of a summer breeze or the cosiness during winter, your living space needs that delicious feeling of wellbeing all year round. Perfera is unobtrusive and features a stylishly designed front panel, whisper-quiet operation and reduced airflow, turning each room into a true haven of conspicuous comfort.

3 unique heating features



heat boost



Heat boost

Heat boost quickly heats up your home when starting up your air conditioner. Set temperature is reached 14% faster* than a regular air conditioner (pair only).

*Heat Plus test condition: 50 class, outdoor temperature 2°C - Indoor temperature 10°C, R/C setting: 23°C



floor warming



Floor warming

The floor warming function optimises convection by distributing hot air from the bottom of the unit.



heat plus



Heat plus

The heat plus function provides cosy heating by simulating radiant heat for 30 minutes. Afterwards, the previous settings are again activated.

Energy efficiency

The enhanced design of the Perfera boosts energy efficiency even further compared with previous models. It boasts a seasonal energy efficiency ratio (SEER) of up to 6.50 and a seasonal coefficient of performance (SCOP) of up to 4.70. This gives the Perfera **best-in-class performance**, with seasonal efficiency values up to A++ in heating resulting in low running costs.

The Perfera is an energy-saving winner from every angle.

up to



in heating & cooling

Intelligent & efficient design

The look of the Perfera floor-standing unit is functional, yet stylish. Its sleek design and flowing lines fit in easily with most contemporary interiors.



Dual airflow: easier individual control of airflow

The dual airflow of the Perfera floor-standing unit is perfect for creating the ideal level of heating. Air is directed both upwards and downwards to deliver even warm air distribution. And when the Perfera is in heat mode, your feet stay warm and the temperature throughout the room is evenly distributed, guaranteeing maximum comfort. Sheer bliss!

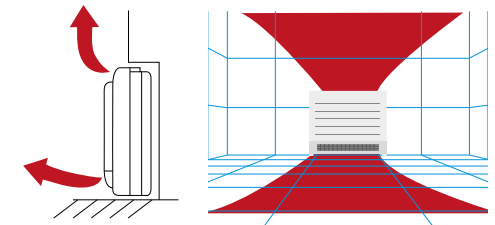

Flash streamer

Using electrons to trigger chemical reactions with airborne particles, the Flash Streamer removes allergens such as pollen and fungal allergens, eliminating unpleasant odours and providing better, cleaner air.

Installation

Whether **built-in or wall-mounted**, the Perfera blends into the background and fits into your interior without any problem.



built-in installation



standard installation



comfora
Discreet wall mounted unit
for high efficiency & comfort

Why choose Comfora?

Comfora is a discreet wall mounted unit that provides you high efficiency and comfort. Thanks to its compact dimensions, it is ideal for above-door installations.



NEW Silver allergen removal filter

The Silver allergen removal and air purifying filter is your solution, because it captures allergens such as pollen to ensure a steady supply of clean air.



NEW 3-D Air flow

By pressing the buttons on the remote control, this function combines vertical and horizontal auto-swing to circulate a stream of cool/warm air right to the corners of even large spaces.

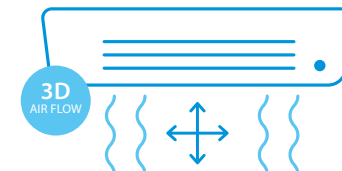

Energy efficiency

Choosing for an R-32 product, reduces the environmental impact with 68% compared to R-410A and leads directly to lower energy consumption thanks to its high energy efficiency.

Seasonal efficiency values up to A++ in cooling and heating.



in heating & cooling



Find your perfect climate

Benefits overview



stylish FTXTA-BW/BB

Where innovation meets creativity, even at ambient temperatures down to -25°C

- › Seasonal efficiency values: A+++ in heating
- › The Coanda effect optimises the airflow for a comfortable climate. By using specially designed flaps, a more focused airflow allows a better temperature distribution throughout the whole room.
- › Fresher, cleaner air thanks to Daikin's Flash Streamer technology: you can breathe deep with no worries about impure air.
- › When installed close to a heating device (e.g. fire place or oven) and the set temperature is reached, the fan keeps on running to have an even temperature throughout the whole house.

BLUEEVOLUTION



Capacity class	Seasonal efficiency (according to EN14825)							Indoor unit				Outdoor unit		Refrigerant	
	Cooling capacity	Heating capacity	Energy label	Pdesign	SEER	SCOP	Annual energy consumption	Dimensions	Sound power level	Sound pressure level		Sound power level	Sound pressure level	Type/GWP	Charge (kg/TCO ₂ Eq)
	Min./Nom./Max. (kW)	Min./Nom./Max. (kW)	Cooling/Heating	Cooling/Heating (kW)	Cooling	Heating	Cooling/Heating (kWh)	H x W x D (mm)	Cooling/Heating (dBA)	Cooling (dBA)	Heating (dBA)	Cooling/Heating (dBA)	Cooling/Heating (dBA) Nom		
30	0.7/3.0/4.5	0.8/3.2/6.9	A+++ / A+++	3.0/2.6	7.63	5.12	138/714	295x798x189	60/60	20/25/32/43	19/24/31/41	61/61	48/49	R-32/675	1.1/0.75

contains fluorinated greenhouse gases



perfera FTXTM-R

Attractive, wall mounted design with perfect indoor air quality, even at ambient temperatures down to -25°C

- › Seasonal efficiency values: full range A+++ in heating
- › Fresher, cleaner air thanks to Daikin's Flash Streamer technology: you can breathe deep with no worries about impure air.
- › When installed close to a heating device (e.g. fire place or oven) and the set temperature is reached, the fan keeps on running to have an even temperature throughout the whole house.
- › Heat boost quickly heats up your home when starting up your airconditioner. Set temperature is reached 14% faster than a regular airconditioner.

BLUEEVOLUTION



Capacity class	Seasonal efficiency (according to EN14825)							Indoor unit				Outdoor unit		Refrigerant	
	Cooling capacity	Heating capacity	Energy label	Pdesign	SEER	SCOP	Annual energy consumption	Dimensions	Sound power level	Sound pressure level		Sound power level	Sound pressure level	Type/GWP	Charge (kg/TCO ₂ Eq)
	Min./Nom./Max. (kW)	Min./Nom./Max. (kW)	Cooling/Heating	Cooling/Heating (kW)	Cooling	Heating	Cooling/Heating (kWh)	H x W x D (mm)	Cooling/Heating (dBA)	Cooling (dBA)	Heating (dBA)	Cooling/Heating (dBA)	Cooling/Heating (dBA) Nom		
30	0.7/3.0/4.5	0.8/3.2/6.7	A+++ / A+++	3.0/3.0	7.6	5.12	138/821	295x778x292	60/61	21/25/33/45	19/22/31/45	61/61	48/49	R-32/675	1.1/0.75
40	0.7/4.0/5.1	0.8/4.0/7.2	A+++ / A+++	4.0/3.8	7.7	5.3	182/1003	299x998x292		20/24/32/46	19/22/31/46				

contains fluorinated greenhouse gases



perfera FLOOR STANDING UNIT - FVXM-A

Floor standing unit for optimal heating comfort thanks to dual airflow, even at ambient temperatures down to -25°C

- › Seasonal efficiency values: full range A+++ in cooling
- › Fresher, cleaner air thanks to Daikin's Flash Streamer technology: you can breathe deep with no worries about impure air.
- › Heat boost quickly heats up your home when starting up your air conditioner. Set temperature is reached 14% faster than a regular air conditioner.
- › The floor warming function optimises convection by distributing hot air from the bottom of the unit.
- › The heat plus function provides 30 min. cosy heating by simulating radiant heat.



Capacity class	Seasonal efficiency (according to EN14825)							Indoor unit				Outdoor unit		Refrigerant	
	Cooling capacity	Heating capacity	Energy label	Pdesign	SEER	SCOP	Annual energy consumption	Dimensions	Sound power level	Sound pressure level		Sound power level	Sound pressure level	Type/GWP	Charge (kg/TCO ₂ Eq)
	Min./Nom./Max. (kW)	Min./Nom./Max. (kW)	Cooling/Heating	Cooling/Heating (kW)	Cooling	Heating	Cooling/Heating (kWh)	H x W x D (mm)	Cooling/Heating (dBA)	Cooling (dBA)	Heating (dBA)	Cooling/Heating (dBA)	Cooling/Heating (dBA) Nom		
25	1.4/2.5/4.2	1.2/3.2/5.7	A+++ / A++	2.5/2.5	6.5	4.7	135/744	600x750x238	52/52	20.0/25.0/38.0	19.0/25.0/38.0	61/61	48/49	R-32/675	1.1/0.75
35	1.4/3.5/4.3	1.2/4.0/6.2		3.5/3	6.1	4.6	201/913		53/53	20.0/25.0/39.0	19.0/25.0/39.0				

contains fluorinated greenhouse gases



comfora FTXTP-M

Discreet wall mounted unit providing high efficiency and comfort, even at ambient temperatures down to -25°C

- › Seasonal efficiency values: full range A+++ in cooling and heating
- › Space saving contemporary wall mounted design
- › 3-D air flow combines vertical and horizontal auto swing to circulate a stream of warm or cool air right to the corners of even large spaces.



Capacity class	Seasonal efficiency (according to EN14825)							Indoor unit				Outdoor unit		Refrigerant	
	Cooling capacity	Heating capacity	Energy label	Pdesign	SEER	SCOP	Annual energy consumption	Dimensions	Sound power level	Sound pressure level		Sound power level	Sound pressure level	Type/GWP	Charge (kg/TCO ₂ Eq)
	Min./Nom./Max. (kW)	Min./Nom./Max. (kW)	Cooling/Heating	Cooling/Heating (kW)	Cooling	Heating	Cooling/Heating (kWh)	H x W x D (mm)	Cooling/Heating (dBA)	Cooling (dBA)	Heating (dBA)	Cooling/Heating (dBA)	Cooling/Heating (dBA) Nom		
25	0.8/2.5/4.0	1.2/3.2/6.2	A+++ / A++	2.5/2.5	7.1	4.93	123/710	285x770x225	58/58	21/26/35/43		61/61	48/49	R-32/675	1.1/0.75
35	0.8/3.5/4.4	1.2/4.0/6.7		3.5/3	7.2	4.81	170/873								

contains fluorinated greenhouse gases



Daikin Optimised Heating 4

In extreme outdoor conditions, you need reliable artillery. The **Optimised heating range 4** is designed to withstand **outside temperatures down to -25°C**, and provides state-of-the-art precision tools against the winter cold.

Now up to **4 different indoor units**, each with its own individual features, can be connected to a single outside unit –shielding you with the latest technology and an **A+++** rating in heating energy-efficiency.



www.daikin.eu



Cutting-edge technology
to beat the winter cold



ECPEN21-010 06/21



Daikin Europe N.V.

Naamloze Vennootschap · Zandvoordestraat 300 · 8400 Oostende · Belgium · www.daikin.eu · BE 0412 120 336 · RPR Oostende (Publisher)

The present publication is drawn up by way of information only and does not constitute an offer binding upon Daikin Europe N.V. Daikin Europe N.V. has compiled the content of this publication to the best of its knowledge. No express or implied warranty is given for the completeness, accuracy, reliability or fitness for particular purpose of its content and the products and services presented therein. Specifications are subject to change without prior notice. Daikin Europe N.V. explicitly rejects any liability for any direct or indirect damage, in the broadest sense, arising from or related to the use and/or interpretation of this publication. All content is copyrighted by Daikin Europe N.V.

Printed on non-chlorinated paper.



Daikin Europe N.V. participates in the Eurovent Certified Performance programme for Liquid Chilling Packages and Hydronic Heat Pumps, Fan Coil Units and Variable Refrigerant Flow systems. Check ongoing validity of certificate: www.eurovent-certification.com